



TRANSAS 4000 MULTIFUNCTION DISPLAY SERIES

- NAVI-SAILOR 4000 ECDIS MFD
- NAVI-RADAR 4000 MFD
- NAVI-CONNING 4000
- NAVI-AMS 4000

TRANSAS 4000 MFD SERIES

Transas 4000 Multifunction Display System (MFD) is a flexible and fully redundant navigation solution providing the operator with a convenient task-oriented environment. The system combines Transas Navi-Sailor 4000 ECDIS MFD, Navi-Radar 4000 MFD, Navi-Conning 4000 and Alarm Monitoring System running simultaneously. All Transas 4000 MFD components are designed in compliance with IMO, IEC, DNV and Lloyds Register requirements.

Transas 4000 MFD is developed to meet requirements of all types of ocean-going commercial vessels, offshore, tankers, cruise ships, super yachts and naval ships, and is ideally suited for both, newbuilds and retrofits.



MFD CONCEPT

Transas 4000 MFD software provides the common base for installation of ECDIS MFD and Radar MFD systems depending on the primary task/ functionality and required certificate:

- **ECDIS MFD** is type-approved Navi-Sailor 4000 ECDIS in basic configuration with optional **Radar Slave** task for external radar connection without scanner control.
- **Radar MFD** is type-approved Navi-Radar 4000 in basic configuration with X or S-band Scanner Set optionally for up or down mast installation depending on configuration. **ECDIS Slave** is optional; accepted as **ECDIS Backup** by some Flag states.

Conning task is optional and when purchased once then is available on all workstations in network and can be displayed on extra monitor connected to any workstation for space saving and cost reduction.

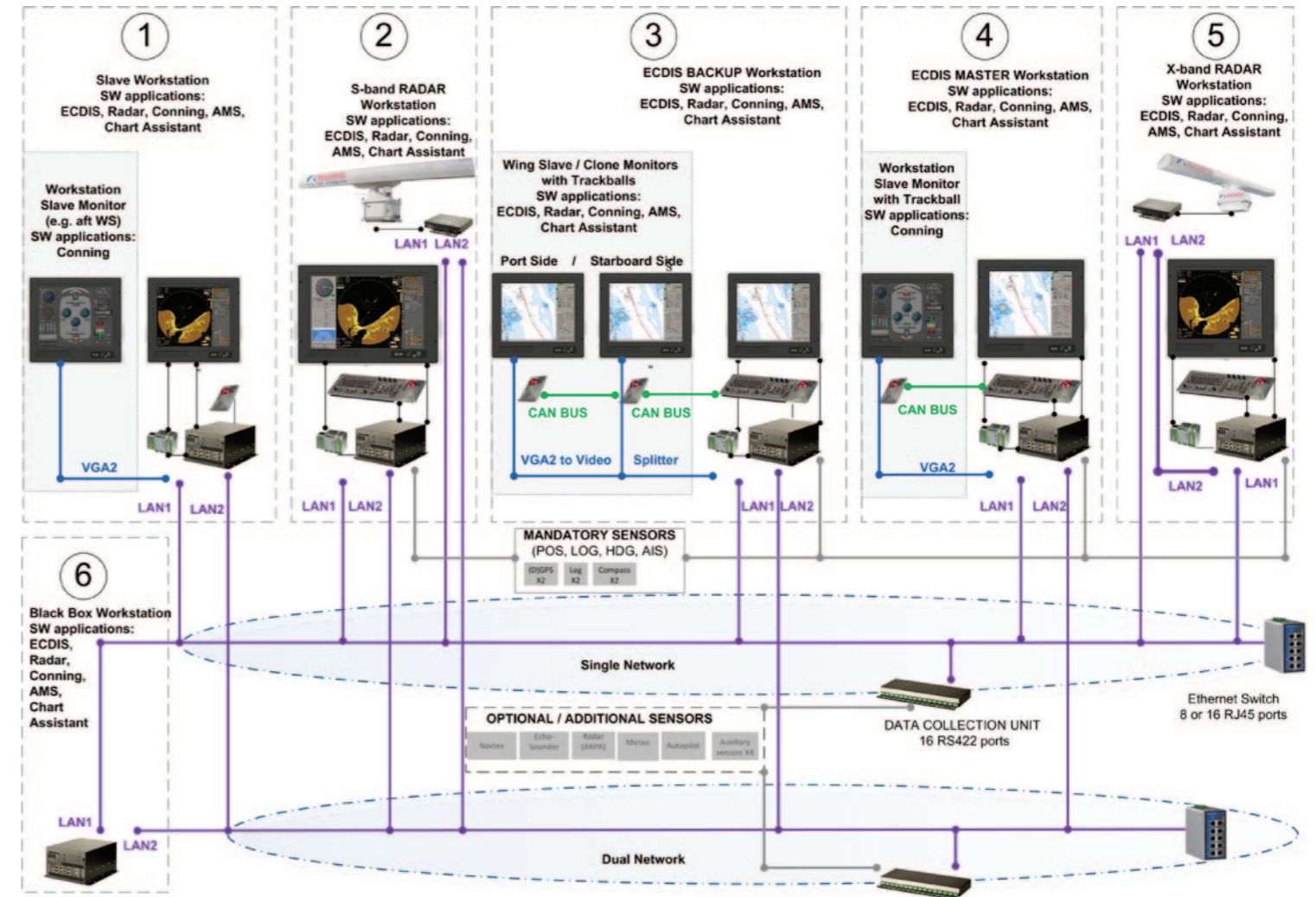

Workstations description

Name	Workstation	Main purpose	Additional purposes by using optional equipment.
X-Band Radar	5	Type Approved X-Band Radar	N/A
S-Band Radar	2	Type Approved S-Band Radar	- Additional ECDIS Backup Workstation - Alarm Monitoring Workstation - Conning Display - Chart Handling Workstation
ECDIS Master	4	Type Approved ECDIS	- Conning Display - Alarm Monitoring System
ECDIS Backup	3	Type Approved ECDIS Backup	- Additional Radar Backup Workstation - Route Planning Workstation - Chart Handling Workstation - Conning Display - Alarm Monitoring Workstation - Wing Monitors for Rescue Workstation
Slave Workstation	1	Additional Workstation	- ECDIS and Radar Slave or Backup Workstation - Route Planning Workstation - Chart Handling Workstation - Conning Display - Aft Workstation
Black Box Workstation	6	Multifunctional Workstation	- Captains Office Workstation - Multi Switch Workstation - Data Recording Workstation

TRANSAS 4000 MFD SERIES

TRANSAS NAVI-SAILOR 4000 ECDIS MFD

Navi-Sailor 4000 ECDIS (Electronic Chart Display and Information System) is the 5th generation of ECDIS from Transas. It can be installed as a standalone system or as Dual ECDIS pre-filled with official ENCs, preparing for the ECDIS carriage requirements and paperless navigation.

Transas Navi-Sailor 4000 ECDIS MFD Features

Graphic User Interface and display

- Various resolutions, 5 skins, 4 palettes, common style with other MFD tasks
- "NorthUp", "CourseUp", "HeadUp" orientation with True/Relative motion mode

Navigation tools

- Route Monitoring and Alarms management
- Generation of SAR operation patterns (reference to std/doc) and RDF support
- Precise Navigation Tools package: Trial Manoeuvring/ Curved Headline and Predictor (Optional)

Planning, Logging and Playback

- Automated keeping of the ship electronic logbook (the E-Logbook is type-approved by DNV but requires flag state approval)
- Events logging automatically, manually and according to set time intervals of up to 1 minute
- Passage planning includes environment data (currents, weather, etc)
- Advanced route planning and validation
- Passage recording playback function in compliance with IEC requirements regarding 12 hour log
- Vessel track recording with high frequency up to 1 second and for period of up to 15 days
- Track to text conversion via built-in Data Tool utility

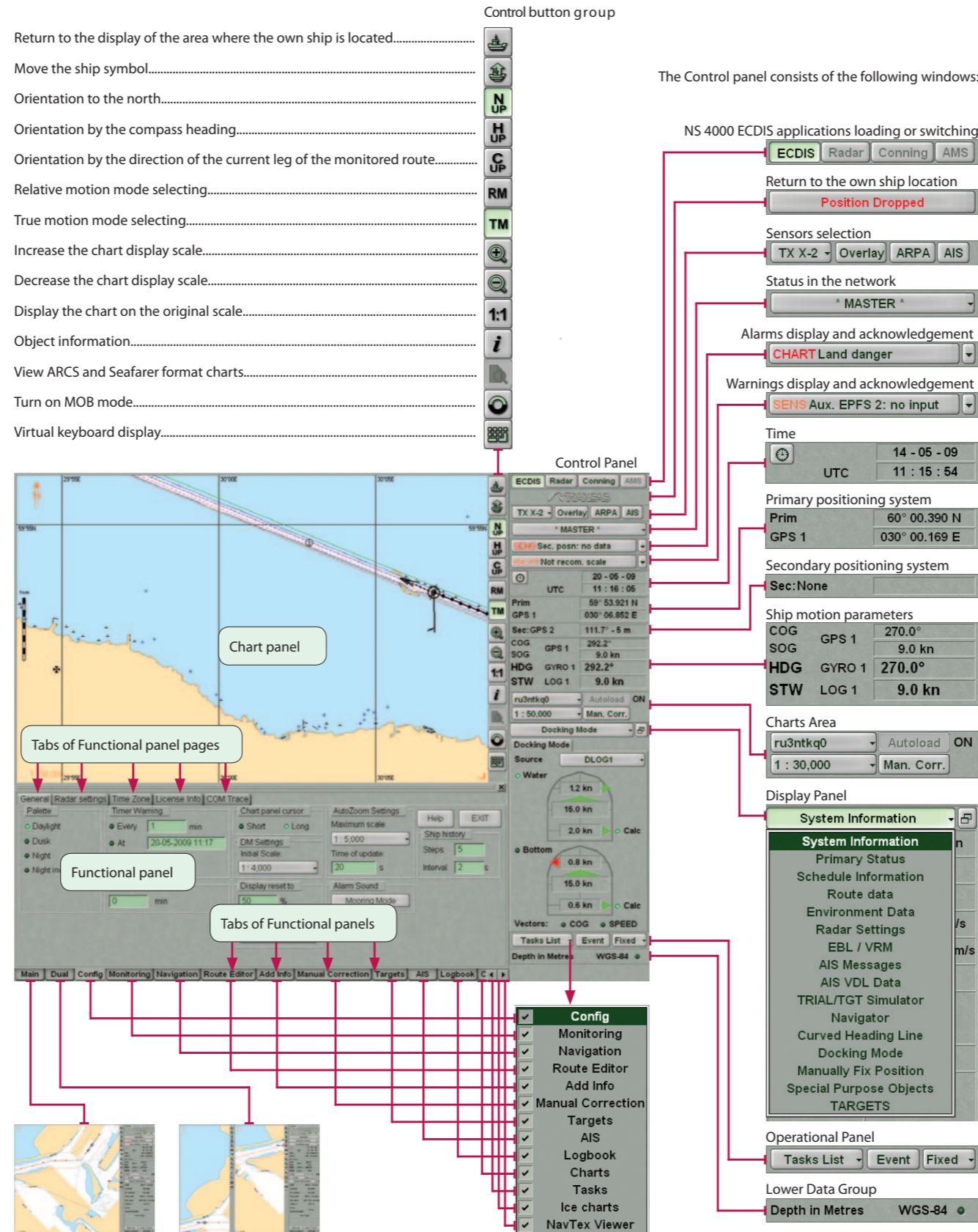

Charts and Databases

- Multiple operation modes with charts in 7 different formats. Primarily official ENC/SENC but also Transas vector TX-97 (with worldwide coverage, ARCS, etc) including online updates.
- World Ports, Magnetic variation, Tides and Currents databases implemented

Sensors

- Connection to RS6 main processor unit NMEA/RS422 serial ports directly
- Discrete signal connection to main unit Digital Input / Output ports
- Analog signal connection via WAGO modules (Onboard systems for presentation on Conning display)
- Additional Sensors connection to 16 NMEA serial ports Data Collector Unit (DCU6)

Interface with External Systems/Sensors

- Integrates with AIS equipment in compliance with IEC61993/2 standard
- AIS binary messaging support (Meteo Info for Great Lakes area e.g.)
- Incorporated Radar Processor board providing the RAW Radar picture overlay from external radar (optional)
- Automatically reads processes and overlays messages from NAVTEX to the electronic navigation chart
- Tender tracking on electronic chart using Seetrac Interface (Optional)
- Input data from the following systems in accordance with IEC 61162-1:
 - Positioning (GGA, GLL, VTG, RMC, DTM, ZDA, GBS, GNS); Gyrocompass x 2 (HDT, ROT); Speed Log (VHW, VBW); Magnetic Compass (HDG); Echo Sounder (DBT, DPT); Wind Sensor (MWD, MWV, VWR); Water Temperature Indicator (MTW); Digitiser YEOMAN (WPL, GLL); Alarm Station (ALR, ACK, analog data via WAGO converters); Customised NMEA sentences; Target data from two ARPAs A/B
- Output the following NMEA data:
 - Navigational Data (GLL, GGA, VTG, VHW, VDR, WPL, RTE, ZDA, XTE, GBS, DTM, HDT, ROT, VBW, APB, BOD, BWC, OSD)
 - Route Segment Transmission (RTE, WPL sentences)
 - Alarms

TRANSAS 4000 MFD SERIES

TRANSAS NAVI-RADAR 4000 MFD

Navi-Radar 4000 MFD is the 3rd generation RADAR system from Transas. A PC-based system, it's fully compliant with the latest IMO, IHO and IEC standards and resolutions for ARPA, AIS and Chart Radar. Navi-Radar 4000 MFD allows full integration and multitasking of Chart Radar/ARPA and ECDIS on one workstation.

Transas Navi-Radar 4000 MFD Features

Graphic User Interface and main ARPA tasks

- User friendly, clear and logically structured interface
- Handling of primary radar information
- Set of ranges: 0,25; 0,5; 0,75; 1,5; 3; 6; 12; 24; 48 nautical miles
- North-up/ Course-up/ Head-up orientation display
- Display of radar information in the true and relative motion modes
- True and relative motion target vectors
- Display of radar picture with centre shifted to up to 2/3 of the screen radius
- Display of two electronic range and bearing lines with offset possibility in drop and carry mode
- Display of four electronic Index lines
- Trial manoeuvre

Charts

- Chart Radar with support of different chart formats: SENC/ ENC/S-57 and Transas TX-97 charts
- Selection of chart infills (coloured, monochrome) or contours
- Separate layer of objects (MAP) for storage of notes and service information not connected with official chart correction data

The image shows a detailed view of the Transas Navi-Radar 4000 MFD interface. It features a central radar display with a green radar picture. Surrounding the display are various control panels and information displays. Annotations with red lines point to specific features:

- Ship motion parameters:** HDG -GYRO 1 000.0°, STW -LOG 1 0.0 kn, COG -GPS 1 000.0°, SOG -GPS 1 0.0 kn.
- Primary position system:** POSN -GPS 1.
- Set the scanner range:** RNG 0.75 NM.
- Distance between range rigs:** RR 0.125 NM.
- Stabilization mode:** GROUND STAB.
- Radar mode and band:** MASTER X-1.
- Set the radar to transmission:** TX.
- Set the pause:** SP.
- Auto or manual true mode:** TUNE AUTO.
- MFD application: loading or switching:** ECDIS Radar Conning AMS.
- Switching layers on/off:** ARPA AIS CHART MAP.
- Alarms display & acknowledgment:** AMS Scanner Control.
- Warning display:** Network reconfig.
- Switching on/off target vectors and their length:** T VECT R VECT 0 min.
- Switching on/off trials:** T TRAIL R TRAIL 17 min.
- Setting of CPA/TCPA limits:** CPA 0.00 NM TCPA 0 min.
- Switching on/off target marks:** Past POSN: 0.5 1 2 4 min.
- Control of target association:** Priority ARPA Association.
- Control of target filtering:** AIS filter S OFF.
- Accumulation of radar signal:** Accumulation: 1 2 3 4 5.
- Clutter suppression facilities:** GAIN RAIN SEA AUTO.
- Control of EBL/VRM:** EBL / VRM 1 EBL / VRM 2, EBL 1 358.6 * T OFFSET, VRM 1 0.36 NM Filled.
- Navigation mode:** NAV MASTER.
- Reference point in use:** CORP: Conning station.
- Cursor data:** CURSOR POSITION T BRG: RNG.
- Control of parallel index line:** RNG NM, T BRG deg.

Targets

- Target data from ARPA for collision avoidance Displays
- Targets form AIS for easy identification
- Association of AIS targets with ARPA targets
- Acquires and processes ARPA tasks (up to 80 targets)
- Displays of up to 256 AIS targets

Interface with External Systems

- Display of a route loaded from external systems ECDIS/positioning system
- Reception of position, course, speed and route information from the connected external sensors in accordance with NMEA 0183 standard;(IEC 61162 ed.1/2)
- Reception of water and ground speed information from the connected dual axis log in accordance with NMEA 0183 standard;(IEC 61162 ed.1/2)
- Reception and display of routes
- Output of tracked targets (ARPA and AIS) parameters in TTM telegram as per NMEA 0183 standard; (IEC 61162 ed.1/2)
- Output of own ship parameters in RSD and OSD telegram as per NMEA 0183 standard; (IEC 61162 ed.1/2)

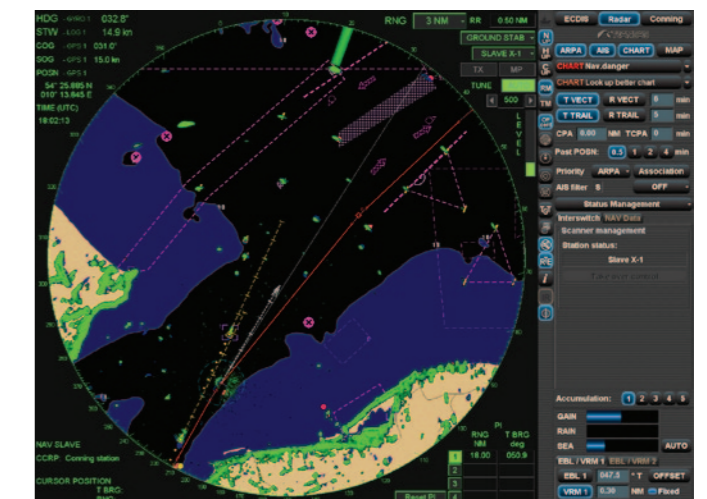

TRANSAS 4000 MFD SERIES

TRANSAS NAVI-CONNING 4000

Transas Conning Display is available as an option to Navi-Sailor 4000 MFD and Navi-Radar 4000MFD and runs on any of the workstations in a 4000 MFD network.

Transas Navi-Conning 4000 Basic Functions

Navi-Conning enables systems integration and ease of craft/vessel control by a navigators team/officer on watch. The system allows an operator to monitor the environment and vessel's primary parameters at a glance. One of Navi-Conning's benefits is the flexibility to meet the bespoke requirements of each customer and to provide optimal information (layout) for different work situations. The customer is able to customise his own Conning Display from a range of existing Screen Views and CCTV Video Servers supported.

Conning customisation

Navi-Conning is a fully customisable product enabling Transas to work closely with its customers to produce a tailored conning package. The main customisations are:

- Creation/design of New Screen Views — each base Screen View can be supplemented with the required indicators available in another base Screen View, whereas unnecessary indicators can be removed. Graphics are vector based and can easily be resized
- Development of New Indicators/graphics — new indicators/graphics can be developed to supplement those provided in the basic Screen View utility
- Development of New Interfaces — various proprietary binary and other interfaces for connection to NC4000

SOFTWARE OPTIONS

Transas Navi-AMS 4000 Alarm Monitoring System

Alarm Monitoring System (AMS) is an additional MFD task to accumulate and display Alarms and Warnings in the MFD from various sources. AMS also indicates which workstation or task generated the Alarm/Warning, and tracks the History.

There are two alarm management system schemes available in the current version:

- Default Alarm management scheme, which conforms to IEC 62288 requirements
- Alarm Station management scheme based on the requirements of:
 - Lloyds register 2003, NAV1 IBS
 - DNV RULES FOR CLASSIFICATION OF SHIPS, NAUT-AW, NAUT-OSV (NAUT-OSV is specific for each ship model)

Configuration of Alarms (Warnings) names and their groups displayed in the Alarm Monitoring System task is available via the integral configuration utility.

Alarms and Warnings may be processed by the following interfaces:

- MFD Alarm interface
- NMEA (ALR, ACK)
- WAGO ADC I/O interface
- RS6 I/O interface

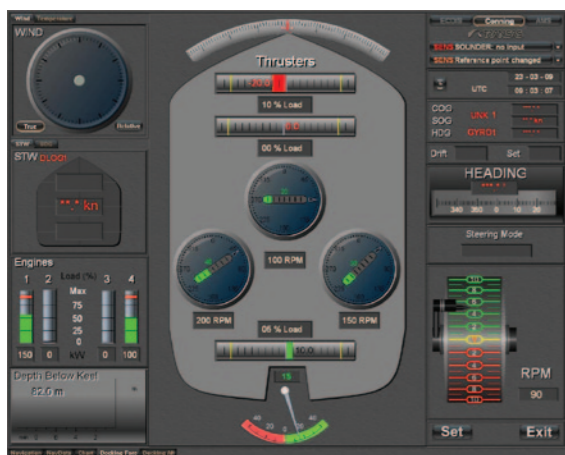

TRANSAS 4000 MFD SERIES

Track Control System

Track control system (TCS) used together with sensors for position, course and speed is designed to keep the vessel on the plotted route. Operation of Track Control functionality is compliant with IEC 62065 standard and is available in 3 categories A/B/C. Transas offers the most advanced category "C" (complete route with controllable turn).

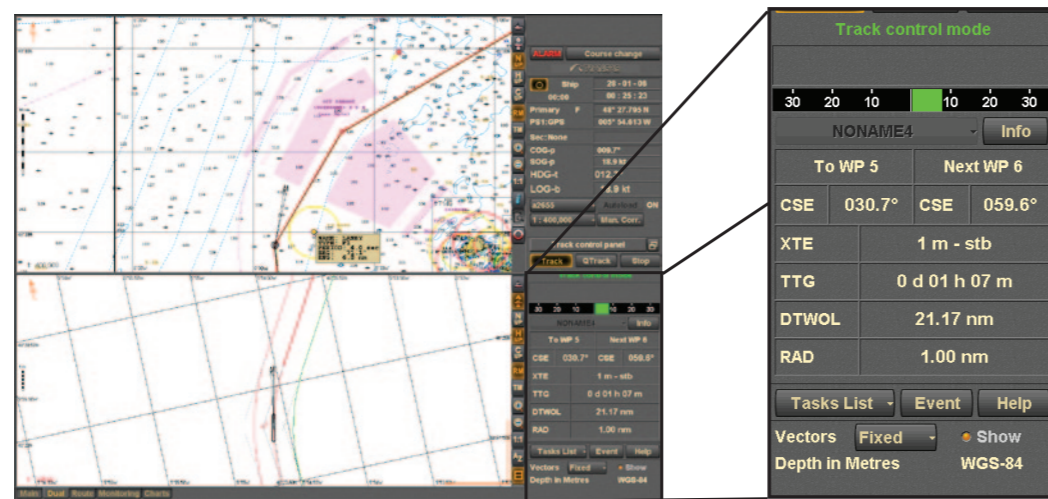

Navi-Planner 4000

Navi-Planner 4000 is an additional integrated application in MFD and a standalone product. The main purpose of Navi-Planner 4000 is to assist the officer to conduct the administrative tasks of voyage planning and create a safe and efficient voyage plan. The user creates a voyage plan with route editor with possibility of route checking to exclude unreliable cartographic areas and calculate under keel clearance (UKC) along a route. The system interacts with various databases to automatically extract the relevant information needed for the plan. Navi Planner 400 is designed to fully plan and conduct a passage plan electronically or as hybrid with a combination of electronic charts and paper publications.

The Voyage Plan functionality was created in close cooperation with OCIMF vetting inspectors, ship owners and navigation officers as well as the IMO Resolutions, like IMO A.916(22) (Guidelines for the recording of events related to navigation) and IMO A.893(21) (Guidelines for Voyage Planning).

Navi-Planner software for onboard and office use offers:

- Port to port planning providing a full and detailed Voyage Plan
- Under Keel Clearance calculation within XTE along planned route
- Automation of navigation tasks and planning
- Detailed Voyage Plan reports
- Reports
- Export and import functions
- Standalone or Integrated with NS 4000 MFD

Transas Navi-Planner 4000 functions:

- Input of general information about vessel and voyage
- Route editor with route checking (safety parameters) and Under Keel Clearance (UKC) calculation
- Schedule creation including ETDs, ETAs and STAY time for each Waypoint. It also offers weather optimising with SPOS (optional)
- Creation of reference points
 - Automatic Generation of editable Reference Points
 - Dangerous Area - Manual Input
 - Reporting Points - Manual Input
- Creation of AddInfo graphic layer that can be used as Aids to Navigation including Lines, Symbols, Text and to each symbol attachments such as PDF, JPEG and BMP
- Information about charts and publications to be used
 - Automatic Charts status of ENC and its corrections
 - Manual Input for Paper Charts and Nautical Publications
- Data collection of Charts, Reference Points, UKC, Tides (Total Tide) and Currents for Voyage plan document and print outs
- Tidal calculations and presentation throughout the voyage
- Printout of Voyage plan and reports as well as print preview
- Export functionality to open format such as Excel, PDF and HTML.

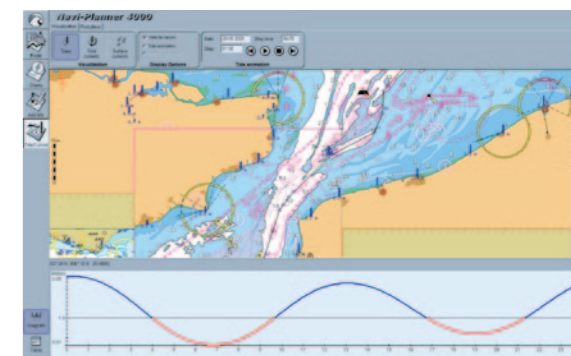
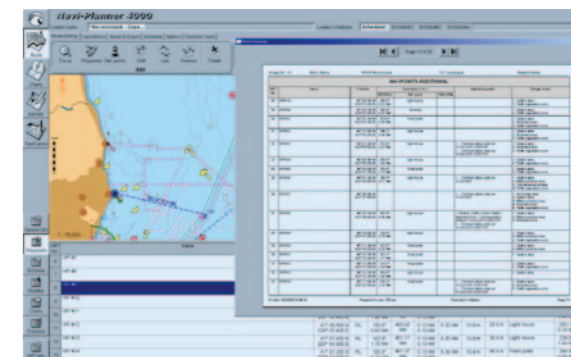
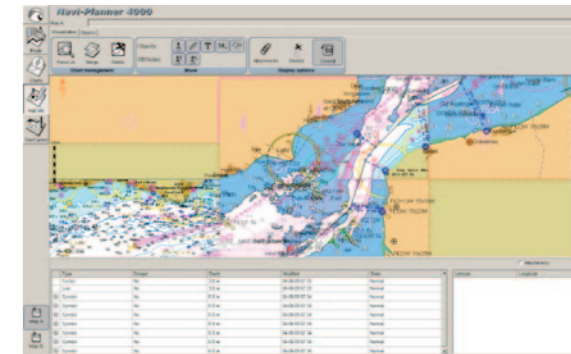

1. GENERAL				
Voyage No.	Ship's Name	Call Sign	MMSI	Master's Name
11111			00000000	Bonan

2. DISTANCE AND TIME				
FROM: Skarvik 510	TO: German Bight LI FI	VIA: Skaw	ETD: 05-10-09 17:30	ETA: 06-10-09 17:58
Berth to Pilot	Pilot to Pilot	Pilot to Berth	Total	
Distance	0.04 NM	223.65 NM	83.96 NM	316.65 NM
Distance (GC)	0.00 NM	0.00 NM	0.00 NM	0.00 NM
Distance (RL)	0.04 NM	223.65 NM	83.96 NM	316.65 NM
Time	00 d 00 h 51 m	00 d 17 h 04 m	00 d 06 h 33 m	01 d 00 h 28 m
Average speed	11.2 kn	13.0 kn	13.0 kn	12.9 kn

TRANSAS 4000 MFD SERIES

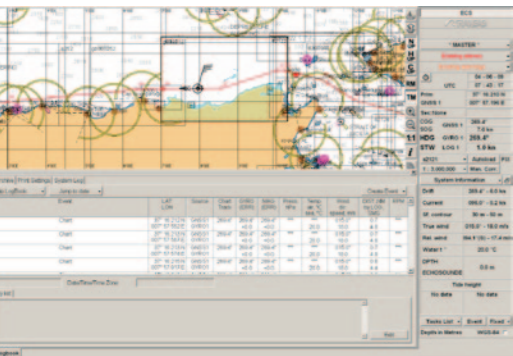
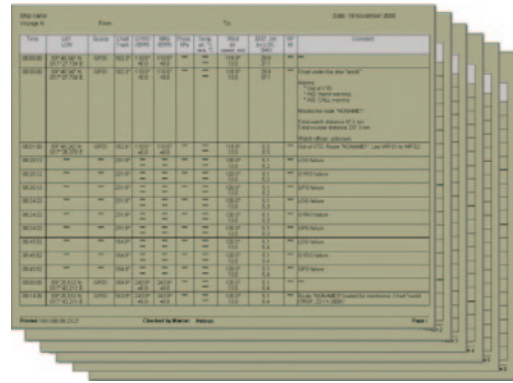
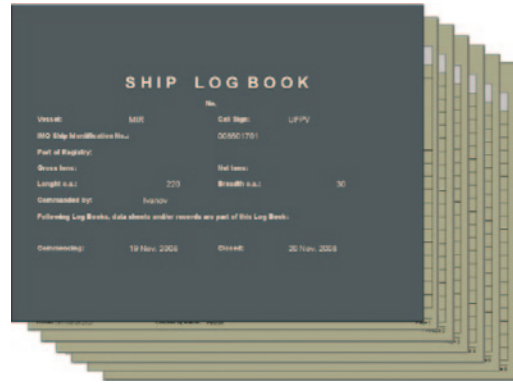

Electronic Logbook

In addition to the standard logbook in Navi-Sailor 4000 ECDIS, Transas have developed an advanced DNV type-approved Electronic Logbook that could replace the ships paper Logbook. The new E-Logbook is based on **IMO Resolution A.916 (22) – Guidelines for the recording of events related to navigation.**

Transas E-Logbook is type-approved by DNV and various flag states (e.g. Norway) to replace the on board paper logbook.

Main features of the E-Logbook:

- Effective Ship's Logbook with presentation similar to paper Ship's Logbook
- Printout replicates paper Ship's Logbook
- Various types of printout
- Entry correction
- Protection from unauthorised entries in Ship's Logbook
- Automatic filling of events by rank and family name of a watch officer
- View all changes made by a watch officer
- Archiving of Logbook at two year duration
- Export Ship's Logbook to read-only format (PDF)
- Transfer archived Logbook external media
- Open and read archived Ship's Logbook
- Print Preview function
- Print out entire Ship's Logbook or desired period using date filter
- Synchronisation in Network

Precise Navigation Tools

(Trial Manoeuvring 3000 / Curved Headline / Predictor)

These functions improve safety of sailing in waters with intensive ship traffic. They can calculate the own ship safe manoeuvre parameters (course, start time).

New functionality allows prediction of the ship's position in a preset time interval and plotting on electronic chart.

Radar Overlay in ECDIS

Radar Overlay software option gives a possibility to display radar overlay from vessel's main radar in Transas Navi-Sailor 4000 ECDIS via Transas Radar Integrator Board RIB 6 or RIB 2. When Transas Navi-Radar 4000 is installed simultaneously with Transas Navi-Sailor 4000 ECDIS, the radar picture is shared on all work stations on the common 4000 MFD network without any additional hardware or software.



FleetView Online

A simple, yet sophisticated internet-based fleet tracking and management package, FleetView Online is a valuable office tool enabling constant vessel monitoring from any web enabled location in a secure online environment.

- Animated weather overlay providing data such as swell, wind direction and significant wave height over a 5-day forecast. Includes detailed Tropical Storms
- Unlimited track history displayed in graphical or tabular form
- Data Position Reports (DPRs) and Polling functionality – via Inmarsat C, Inmarsat D+ or Inmarsat Mini-C.
- Proven system to support crisis management (ISM Code requirement)
- User definable chart areas and port shortcuts (search by country/region)

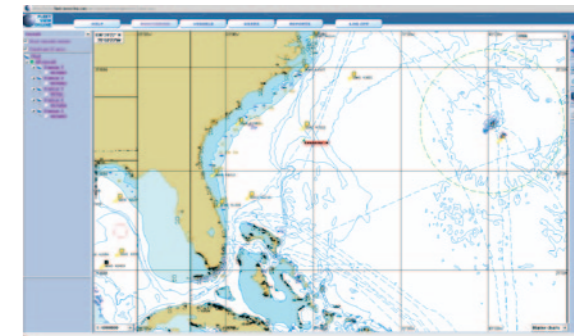

Ice charts option

Ice charts contain the distribution of ice of different age, concentration and forms. This feature displays ice conditions for a certain sea area or the whole sea.

ECDIS MFD allows simultaneous display of up to 6 different semi-transparent layers (different kinds of ice information), with an individual transparency setting for each layer.

The following Ice Chart formats can be presented:

- **Ice condition Actual** – Actual charts of ice allocation in S-57 format. Charts are based on information from NOAA, Terra, Radarsat, data from hydro-meteo-stations and vessels
- **Ice condition forecast** – Forecast charts of ice allocation in S-57 format
- **Recommended Ways** – Recommended ways for ice navigation presented in S-57 format
- **Images** – Raster images from satellites (Geo TIFF)



TRANSAS 4000 MFD SERIES

Scanners

Scanner type	Antenna length	Power	Weight, kg (Outer Assembly / Inner Accessories)
S – Band	12 feet	30 kW	255 / 12
X – Band	9 feet	25 kW	44 / 6
X – Band	9 feet	12 kW	44 / 6
X – Band	7.5 feet	10 kW	38.7 / 7
X – Band	6 feet	25 kW	40 / 6
X – Band	6 feet	10 kW	36.3 / 7
X – Band	6 feet	4 kW	36.3 / 7
X – Band	4 feet	4 kW	34.3 / 7

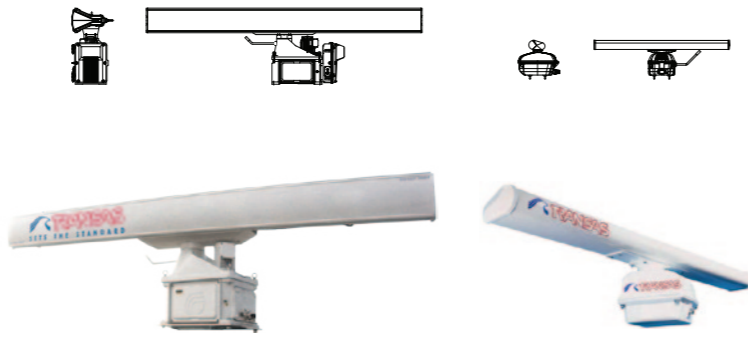

Monitors

Monitor type	Dimensions, mm			Weight, kg (w/bracket)
	H	B	D	
19"	483	444	82	11.5
23"	584	534	85	17.0
27"	660	481	102	16.0



Computers

RS6 PC	Dimensions, mm			Weight, kg
	H	B	D	
PC	150	220	300	—
PC with brackets	150	260	300	5.0

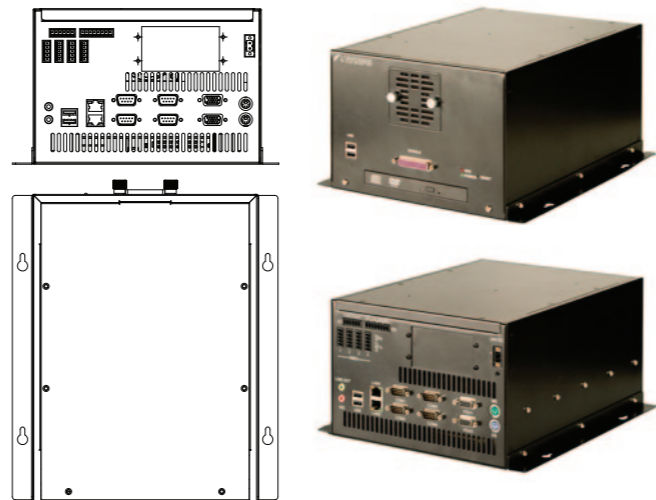

Keyboards

ES6 Keyboard and Trackball	Dimensions, mm			Weight, kg
	H	B	D	
Keyboard and Trackball	Overall – 80	464	166	1.9
Trackball only	Chassis – 35	105	166	0.4

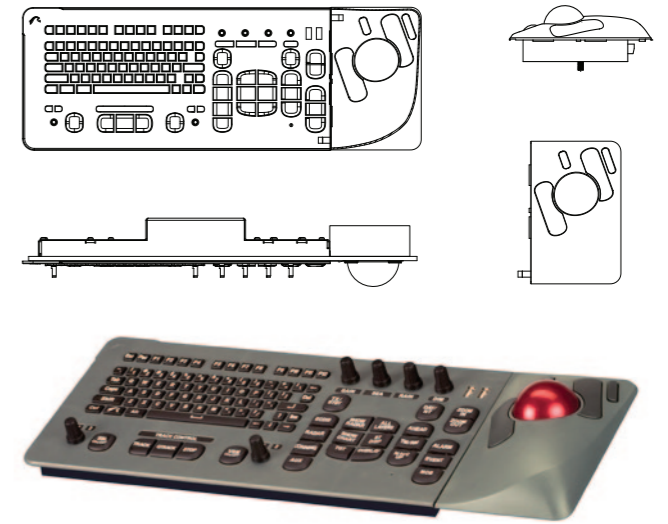

Options and Accessories

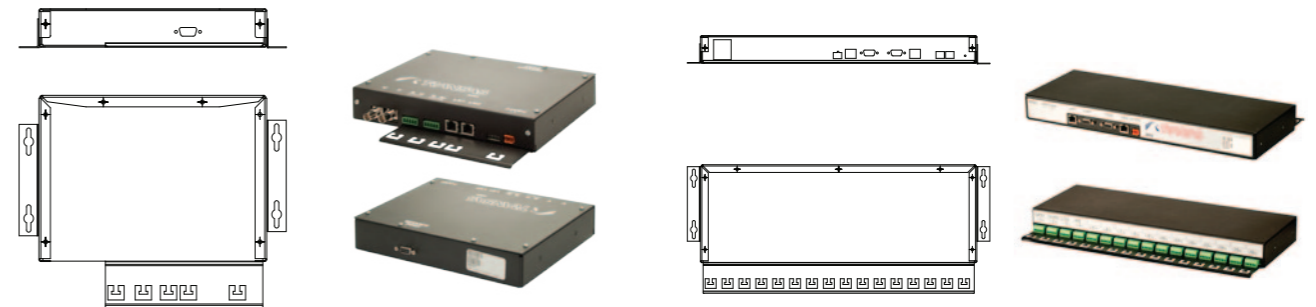

RIB6	Dimensions, mm			Weight, kg
	H	B	D	
RIB6 with brackets	Overall – 40	278	221	1.3
RIB6	Overall – 40	237	221	—

DCU6	Dimensions, mm			Weight, kg
	H	B	D	
DCU6 with brackets	Overall – 43	470	199	2.7
DCU6	Overall – 43	430	199	—

Ethernet switch	Dimensions, mm			Weight, kg
	H	B	D	
8 ports	54	145	117 (without DIN rail)	0.7
16 ports	73	145	117 (without DIN rail)	1.2

UPS	Dimensions, mm			Weight, kg
	H	B	D	
220VAC – 24VDC	132	306	153	6.2
24CDC – 24VDC	132	178	153	4.3

TRANSAS WORLDWIDE DISTRIBUTORS AND SERVICE NETWORK

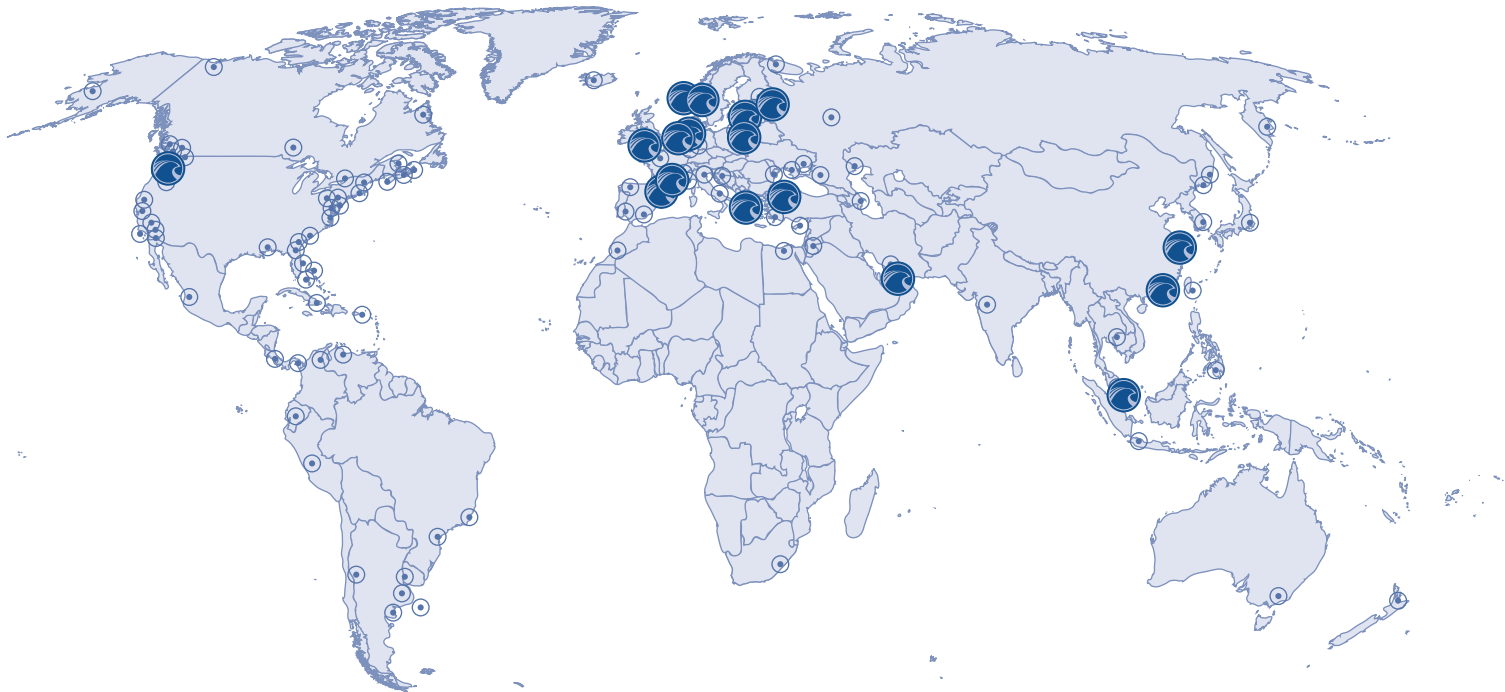

TRANSAS MARINE INTERNATIONAL

tel.: +46 31 769 56 00
fax: +46 31 694 184
e-mail: info@transas.com
sales@transas.se

TRANSAS USA INC.

tel.: +1 425 486 2100
fax: +1 425 486 2112
e-mail: sales@transasusa.com

TRANSAS MARINE PACIFIC PTE LTD.

tel.: +65 627 10 200
fax: +65 627 17 300
e-mail: info.asia@transas.com

TRANSAS MARINE GMBH

tel.: +49 40 890 6660
fax: +49 40 881 1379
e-mail: info@transas.de

TRANSAS MEDITERRANEAN SAS

tel.: +33 4 89 86 4100
fax: +33 4 89 86 4129
e-mail: med-sales@transas.com

TRANSAS MARINE (UK) LTD.

tel.: +44 2392 674 000
fax: +44 2392 674 048
e-mail: tmuk.sales@transas.com

TRANSAS MIDDLE EAST

tel.: +97 14 324 1415
fax: +97 14 324 1550
e-mail: tme@transas.com

TRANSAS BENELUX

tel.: +31 10 428 5599
fax: +31 10 428 5590
e-mail: benelux@transas.com

TRANSAS CHINA

tel.: +86 21 3392 6750
fax: +86 21 3392 6790
e-mail: info.china@transas.com

TRANSAS HONG KONG LTD.

tel.: +852 281 516 03
fax: +852 281 516 90
e-mail: info@transas.com.hk

TRANSAS BLACK SEA

tel.: +90 216 337 0852
fax: +90 216 337 0852
e-mail: blacksea@transas.com

TRANSAS MARINE SPAIN

tel.: +34 93 424 5589
fax: +34 93 426 8678
e-mail: sales@transas-es.com

TRANSAS MARINE NORWAY

tel.: +47 91 70 5060
fax: +47 94 76 2319
e-mail: sales@transas.no

TRANSAS HELLAS LTD.

tel.: +30 210 899 5164
fax: +30 210 899 5218
e-mail: hellas@transas.com

TRANSAS MARINE POLAND

tel.: +48 58 774 7283
fax: +48 58 774 7283
e-mail: sales@transas.de

TRANSAS BALTIC SIA

tel.: +371 6 716 2100
fax: +371 6 716 2101
e-mail: baltic@transas.com

TRANSAS NAVIGATOR

tel.: +7 812 325 3131
fax: +7 812 325 3132
e-mail: trn@transas.com

WWW.TRANSASMARINE.COM



© Transas Marine Ltd. 1991–2010. All rights reserved.

